

Linear

# LINI-R R014

## Fixture Guide

# KKDC

Indoor | Recessed | Output up to 230lm/m (70lm/ft)



### Key applications

- ✓ Ceiling
- ✓ Downlighting
- ✓ Direct lighting
- ✓ Interior

### Key features

- ✓ Custom lengths
- ✓ Extensive CCT range
- ✓ Constant Voltage (CV)
- ✓ IP40 dry area
- ✓ Diffusion: homogenous
- ✓ IP44 moisture resistant

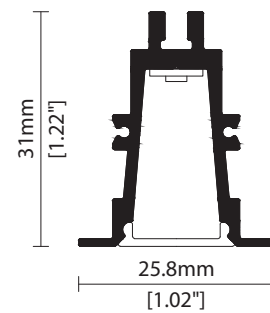



### FIXTURE

Model	Finish	Cover <sup>1</sup>	Grade <sup>2</sup>	LED	Colour (CCT)	Length Availability <sup>3</sup>	IP	Cable Length	Power Feed <sup>4</sup>	Input
LINE-R LR	Silver Anodised SA	Diffused C	s- s k- k	R014 R014	1900K 19	m 100.3-2017mm 83.3mm increments	IP40 40	50mm/1.97" 0050	Single no sheath tail S00X	DC 24V g
					2100K 21					
					2300K 23	i 3.95-79.41in 3.28in increments	IP44 44	300mm/11.81" 0300	Double no sheath tail D00X	
					2500K 25					
					2700K 27	(Specify length code OR total run length)		1000mm/39.37" 1000	Single no sheath IP20 connector S20X	
					3000K 30					
					3500K 35					
					4000K 40					
					5000K 50					
					RED RED s- only					
					GREEN GRN				Double no sheath IP20 connector D20X	
					BLUE BLU					
					ORANGE ORN					
					AMBER AMB					

<sup>1</sup> Refer to **Cover/Lens options** on **Options** page

<sup>2</sup> Refer to **LED Grading Key** on **Specification sheet** page

<sup>3</sup> Refer to **Length Availability List** or enter total run length instead of length code

<sup>4</sup> Refer to **Power Feed Options** on **Options** pages

### Code Example:

LR	-	SA	-	C	-	s	-	R014	-	35	-	m	517	-	40	-	0300	-	D00X	-	g
LINE-R		Silver Anodised		Diffused		s		R014		3500K		517mm		IP40		300mm/11.81"		Double no sheath tail		DC 24V	

### ACCESSORIES

#### Connection Accessories

KKCN-01	2 PIN male & female 50mm/1.97" pair
KKCN-03	2 PIN male & female 300mm/11.81" pair
KKCN-06	2 PIN 300mm/11.81" extension lead

#### PSU/Driver

0-10V/1-10V/DALI/DMX

\* Refer to **Driver/PSU Options** page for details or provide requirement and KKDC to offer the suitable option

\* Refer to **Power feed** on **Accessories** pages

### LED ENGINE VARIANTS (LED STRIP TYPE)

Colour	LED	Lumen/m	Lumen/ft	W/m	W/ft	Spec Doc	Length	Increment
Single CCT	R007	230	70	7	2.13	LINE-R R007	100-2017mm (3.93-79.41in)	41.7mm (1.64in)
	<b>R014</b>	<b>475</b>	<b>145</b>	<b>14</b>	<b>4.27</b>	<b>LINE-R R014</b>	<b>100-2017mm (3.93-79.41in)</b>	<b>41.7mm (1.64in)</b>
Warm Dim/Dynamic White	R020	678	207	20	6.10	LINE-R R020	100-2017mm (3.93-79.41in)	41.7mm (1.64in)
	R207	546	166	16	6.10	LINE-R R207	100-2017mm (3.93-79.41in)	83.3mm (3.28in)
RGB	501	Red: 54 Green: 116 Blue: 19 RGB: 167	Red: 16 Green: 35 Blue: 6 RGB: 51	15.6	4.75	LINE-R RGB	100-2017mm (3.93-79.41in)	83.3mm (3.28in)

\* Performance data: s-line, 3000K, diffused cover

# LINE-R R014

## Length Availability List



Length Code		Fixture Length <sup>1</sup>		LED Strip <sup>2</sup>		End Cap Dimension		Wattage (W)	Output (lm)
Metric	Imperial(US)	Metric	Imperial(US)	Metric	Imperial(US)	Metric	Imperial(US)		3000K (Test Data)
m0100	i0004	100mm	3.95in	83mm	3.28in	12mm	0.47in	1.17	37
m0142	i0006	142mm	5.59in	125mm	4.92in	12mm	0.47in	1.75	56
m0184	i0007	184mm	7.23in	167mm	6.56in	12mm	0.47in	2.33	75
m0225	i0009	225mm	8.87in	208mm	8.20in	12mm	0.47in	2.92	93
m0267	i0011	267mm	10.51in	250mm	9.84in	12mm	0.47in	3.50	112
m0309	i0012	309mm	12.15in	292mm	11.48in	12mm	0.47in	4.08	131
m0350	i0014	350mm	13.79in	333mm	13.12in	12mm	0.47in	4.67	149
m0392	i0015	392mm	15.43in	375mm	14.76in	12mm	0.47in	5.25	168
m0434	i0017	434mm	17.07in	417mm	16.40in	12mm	0.47in	5.83	187
m0475	i0019	475mm	18.71in	458mm	18.04in	12mm	0.47in	6.42	205
m0517	i0020	517mm	20.35in	500mm	19.69in	12mm	0.47in	7.00	224
m0559	i0022	559mm	21.99in	542mm	21.33in	12mm	0.47in	7.58	243
m0600	i0024	600mm	23.64in	583mm	22.97in	12mm	0.47in	8.17	261
m0642	i0025	642mm	25.28in	625mm	24.61in	12mm	0.47in	8.75	280
m0684	i0027	684mm	26.92in	667mm	26.25in	12mm	0.47in	9.33	299
m0725	i0029	725mm	28.56in	708mm	27.89in	12mm	0.47in	9.92	317
m0767	i0030	767mm	30.20in	750mm	29.53in	12mm	0.47in	10.50	336
m0809	i0032	809mm	31.84in	792mm	31.17in	12mm	0.47in	11.08	355
m0850	i0033	850mm	33.48in	833mm	32.81in	12mm	0.47in	11.67	373
m0892	i0035	892mm	35.12in	875mm	34.45in	12mm	0.47in	12.25	392
m0934	i0037	934mm	36.76in	917mm	36.09in	12mm	0.47in	12.83	411
m0975	i0038	975mm	38.40in	958mm	37.73in	12mm	0.47in	13.42	429
m1017	i0040	1017mm	40.04in	1000mm	39.37in	12mm	0.47in	14.00	448
m1059	i0042	1059mm	41.68in	1042mm	41.01in	12mm	0.47in	14.58	467
m1100	i0043	1100mm	43.32in	1083mm	42.65in	12mm	0.47in	15.17	485
m1142	i0045	1142mm	44.96in	1125mm	44.29in	12mm	0.47in	15.75	504
m1184	i0047	1184mm	46.60in	1167mm	45.93in	12mm	0.47in	16.33	523
m1225	i0048	1225mm	48.24in	1208mm	47.57in	12mm	0.47in	16.92	541
m1267	i0050	1267mm	49.88in	1250mm	49.21in	12mm	0.47in	17.50	560
m1309	i0052	1309mm	51.52in	1292mm	50.85in	12mm	0.47in	18.08	579
m1350	i0053	1350mm	53.16in	1333mm	52.49in	12mm	0.47in	18.67	597
m1392	i0055	1392mm	54.80in	1375mm	54.13in	12mm	0.47in	19.25	616
m1434	i0056	1434mm	56.44in	1417mm	55.77in	12mm	0.47in	19.83	635
m1475	i0058	1475mm	58.08in	1458mm	57.41in	12mm	0.47in	20.42	653
m1517	i0060	1517mm	59.72in	1500mm	59.06in	12mm	0.47in	21.00	672
m1559	i0061	1559mm	61.36in	1542mm	60.70in	12mm	0.47in	21.58	691
m1600	i0063	1600mm	63.01in	1583mm	62.34in	12mm	0.47in	22.17	709
m1642	i0065	1642mm	64.65in	1625mm	63.98in	12mm	0.47in	22.75	728
m1684	i0066	1684mm	66.29in	1667mm	65.62in	12mm	0.47in	23.33	747
m1725	i0068	1725mm	67.93in	1708mm	67.26in	12mm	0.47in	23.92	765
m1767	i0070	1767mm	69.57in	1750mm	68.90in	12mm	0.47in	24.50	784
m1809	i0071	1809mm	71.21in	1792mm	70.54in	12mm	0.47in	25.08	803
m1850	i0073	1850mm	72.85in	1833mm	72.18in	12mm	0.47in	25.67	821

# LINI-R R014

## Length Availability List



Length Code		Fixture Length <sup>1</sup>		LED Strip <sup>2</sup>		End Cap Dimension		Wattage (W)	Output (lm) 3000K (Test Data)
Metric	Imperial(US)	Metric	Imperial(US)	Metric	Imperial(US)	Metric	Imperial(US)		
m1892	i0074	1892mm	74.49in	1875mm	73.82in	12mm	0.47in	26.25	840
m1934	i0076	1934mm	76.13in	1917mm	75.46in	12mm	0.47in	26.83	859
m1975	i0078	1975mm	77.77in	1958mm	77.10in	12mm	0.47in	27.42	877
m2017	i0079	2017mm	79.41in	2000mm	78.74in	12mm	0.47in	28.00	896

<sup>1</sup> Actual total overall length of light fixture (LED strip + end caps + void/wire hole)

<sup>2</sup> Actual length of PCB strip

<sup>3</sup> Actual length of 2x end caps

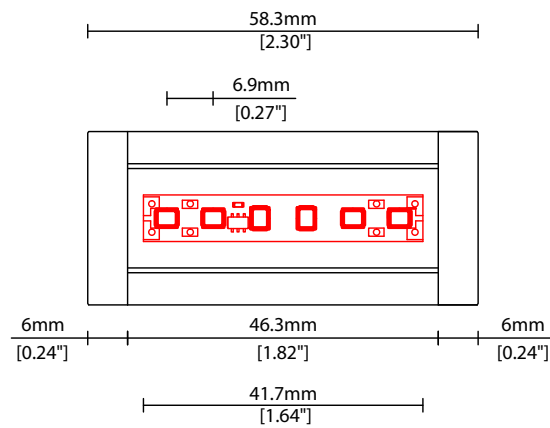



# LINI-R R014

## Options



### COVER/LENS OPTIONS

\* Options are an integral part of the fixture ordering codes. Please refer to **Code Table** pages.

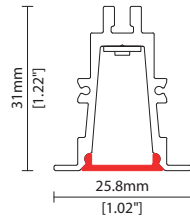

C Diffused cover  
W25.8/H31mm (W1.02/H1.22")

### POWER FEED OPTIONS

\* Options are an integral part of the fixture ordering codes. Please refer to **Code Table** pages.

**0050 S20X 50mm (1.97") Single no sheath IP20 connector**

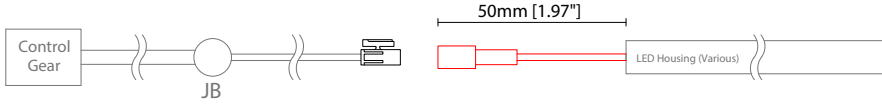

**0050 D20X 50mm (1.97") Double no sheath IP20 connector**

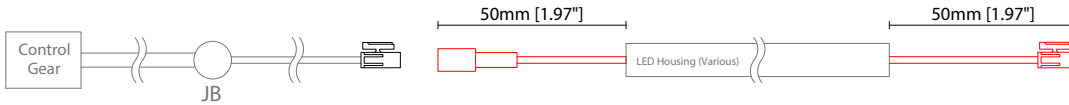

**0300 S00X 300mm (11.81") Single no sheath tail**

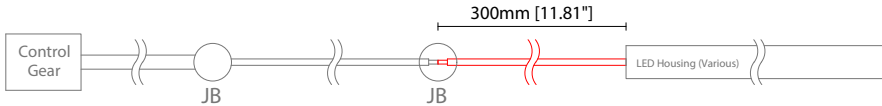

**0300 D00X 300mm (11.81") Double no sheath tail**

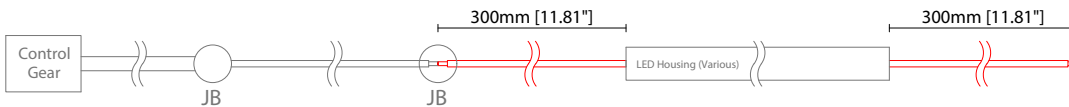

**0300 S20X 300mm (11.81") Single no sheath IP20 connector**

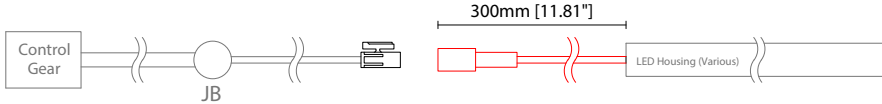

**0300 D20X 300mm (11.81") Double no sheath IP20 connector**

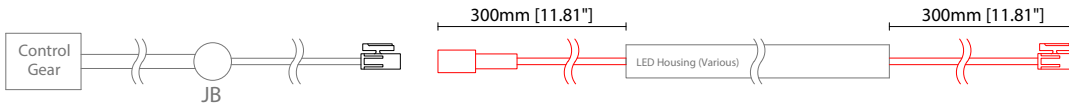

**1000 S00X 1000mm (39.37") Single no sheath tail**

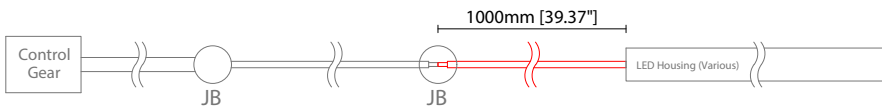

**1000 D00X 1000mm (39.37") Double no sheath tail**

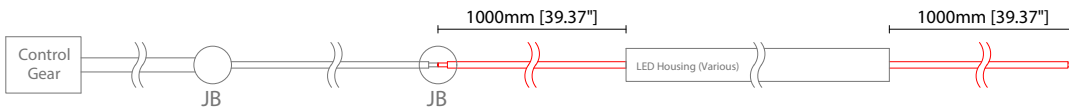

**1000 S20X 1000mm (39.37") Single no sheath IP20 connector**

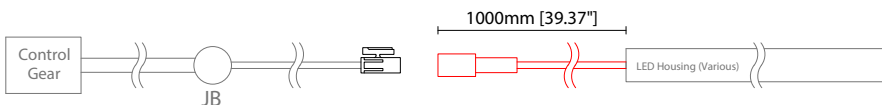

#### Key

Control Gear Power supply, sub-controllers & control systems

JB Junction box / cable connection

### POWER FEED OPTIONS (CONTINUED)

1000 D20X 1000mm (39.37") Double no sheath IP20 connector

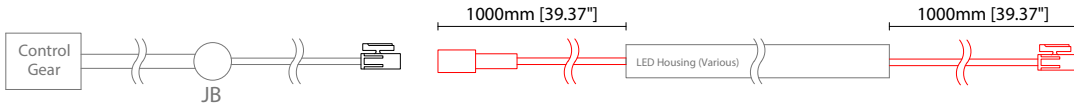

2 Pin Female Connector

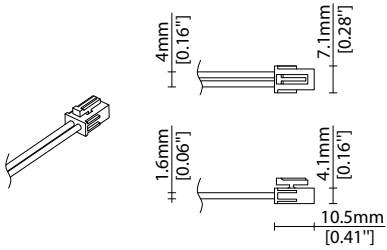

2 Pin Male Connector

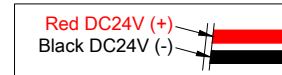
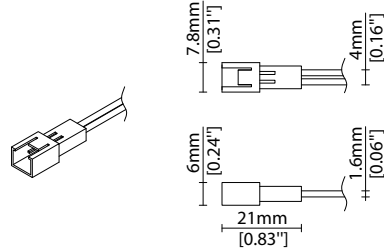

#### Key

Control Gear Power supply, sub-controllers & control systems  
 JB Junction box / cable connection

Linear

# LINI-R R014 Accessories

# KKDC

## POWER FEED

Note: Accessories are to be ordered separately with corresponding code shown below.

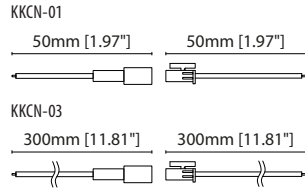
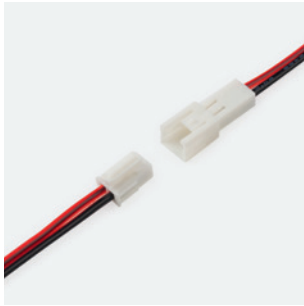

**KKCN-01** 50mm (1.97in) pair  
**KKCN-03** 300mm (11.81in) pair  
2 PIN male + female connector set

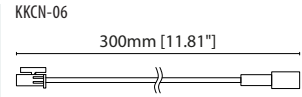

**KKCN-06**  
2 PIN 300mm (11.81in) extension  
lead

### KKDC CONTROL



IP20  
Plastic housing  
L170/W59/H29mm  
(L6.69/W2.32/H1.14in)

**KKDM-06** 1-10V  
visDIM dimmable sub-controller  
(4 x 8A max @ 12-36V)



IP20  
Plastic housing  
L170/W53.4/H28mm  
(L6.69/W2.10/H1.10in)

**KKSC-05** DMX  
visDIM dimmable sub-controller  
(4 x 5A max @ 12-36V)



IP20  
Plastic housing  
L170/W59/H29mm  
(L6.69/W2.32/H1.14in)

**KKDL-02** DALI  
visDIM dimmable sub-controller  
(4 x 8A max @ 12-36V)



IP20  
Plastic housing  
L166/W53.4/H23mm  
(L6.54/W2.10/H0.91in)

**KKDL-03** DALI  
visDIM dimmable sub-controller  
(4 x 5A max @ 12-36V)



IP20  
Plastic housing  
L170/W53.4/H28mm  
(L6.69/W2.10/H1.10in)

**KKDL-04** DALI-2  
visDIM dimmable sub-controller  
(4 x 5A max @ 12-36V)

### AVAILABLE PSU OPTIONS

Control Mode	PSU (Order Code)	Input Voltage AC	Output Voltage DC	Rated Output Current	Rated Power	Dim %	IP Rating
Switched	CEN-60-24	90-295V	24V	2.5A	60W	-	IP67
	HLG-60H-24	90-305V	24V	2.5A	60W	-	IP67
	HLG-100H-24	90-305V	24V	4.0A	100W	-	IP67
	HLG-150H-24	90-305V	24V	6.3A	150W	-	IP67
	HLG-240H-24	90-305V	24V	10A	240W	-	IP67
0-10V (1-10V)	PWM-40-24	90-305V	24V	1.67A	40W	100-0.15 (100-10)	IP67
	PWM-60-24	90-305V	24V	2.5A	60W	100-0.15 (100-10)	IP67
	PWM-90-24	90-305V	24V	3.67A	90W	100-0.15 (100-10)	IP67
	PWM-120-24	90-305V	24V	5.0A	120W	100-0.15 (100-10)	IP67
DALI	LIN100A1	120-277V	24V	1A per channel	100W	100-0.1	IP66/IP40
DMX RGB	LIN100A1	120-277V	24V	1.33A per channel	100W	100-0.1	IP66/IP40
DMX RGBW	LIN100A1	120-277A	24V	1A per channel	100W	100-0.1	IP66/IP40

### Flicker Free Options - Combination of PSU+ sub-controller

Control Mode	PSU (Order Code)	Sub-controller (Order Code)	Input Voltage AC	Output Voltage DC	Rated Output Current	Rated Power	Dim %	IP Rating PSU/ Sub-controller
0-10V or 1-10V	CEN-60-24	KKDM-06	90-295V	24V	2.5A	60W	100-0.9	IP67/IP20
	HLG-60H-24	KKDM-06	90-295V	24V	2.5A	60W	100-0.9	IP67/IP20
	HLG-100H-24	KKDM-06	90-295V	24V	4.0A	100W	100-0.9	IP67/IP20
	HLG-150H-24	KKDM-06	90-295V	24V	6.3A	150W	100-0.9	IP67/IP20
	HLG-240H-24	KKDM-06	90-295V	24V	10.0A	240W	100-0.9	IP67/IP20
DALI	CEN-60-24	KKDL-02/03/04/visDIM PRO 30	90-295V	24V	2.5A	60W	100-0.1	IP67/IP20
	HLG-60H-24	KKDL-02/03/04/visDIM PRO 30	90-305V	24V	2.5A	60W	100-0.1	IP67/IP20
	HLG-100H-24	KKDL-02/03/04/visDIM PRO 30	90-305V	24V	4.0A	100W	100-0.1	IP67/IP20
	HLG-150H-24	KKDL-02/03/04/visDIM PRO 30	90-305V	24V	6.3A	150W	100-0.1	IP67/IP20
	HLG-240H-24	KKDL-02/03/04/visDIM PRO 30	90-305V	24V	10.0A	240W	100-0.1	IP67/IP20
DMX RGB	CEN-60-24	KKSC-05	90-295V	24V	2.5A	60W	100-0.9	IP67/IP20
	HLG-60H-24	KKSC-05	90-305V	24V	2.5A	60W	100-0.9	IP67/IP20
	HLG-100H-24	KKSC-05	90-305V	24V	4A	100W	100-0.9	IP67/IP20
	HLG-150H-24	KKSC-05	90-305V	24V	6.3A	150W	100-0.9	IP67/IP20
	HLG-240H-24	KKSC-05	90-305V	24V	10.0A	240W	100-0.9	IP67/IP20

<sup>1</sup> The items shown above cover the most frequently used specification but does not exhaust the possible options

<sup>2</sup> PSU and/or driver can be chosen from the table, or KKDC may recommend the best option upon receipt of the controls requirement and installation environment

<sup>3</sup> Electrical shop drawing will include detailed information of PSU and relevant control drivers

<sup>4</sup> Cut sheets are available on the controls section of [www.kkdc.lighting](http://www.kkdc.lighting) or upon request